

GENERAL OPERATING INSTRUCTIONS AND PARTS LIST

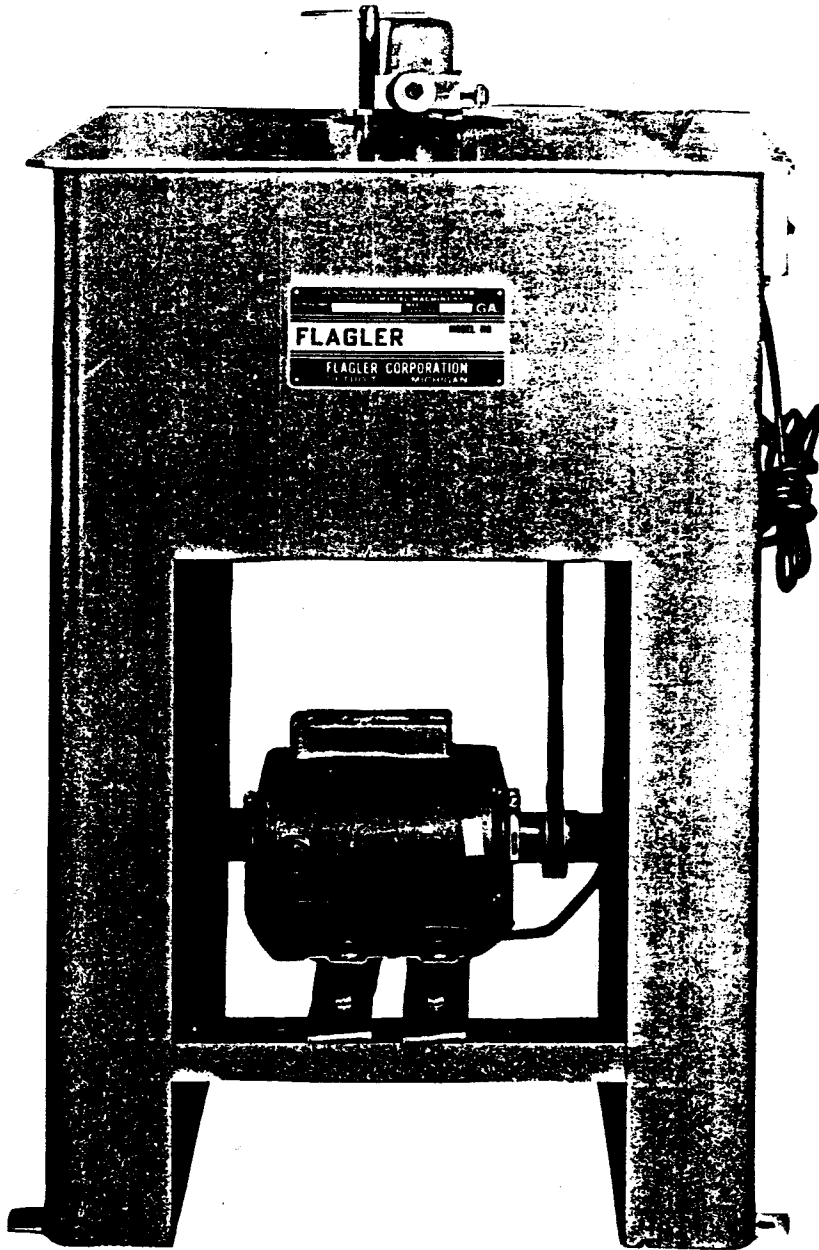

18 GA POWER FLANGER

OUR NEW
AREA CODE IS
586

the **flagler** corp.

56513 PRECISION DR.
CHESTERFIELD, MI 48051
810.749.6300 F.810.749.6363
WWW.FLAGLERCORP.COM

The adjusting dial on the flanging head must be set to the gauge to be handled. To do this, turn the dial to the right as far as it will go (without forcing); then back off until the number of the gauge to be worked is opposite the scribed mark.

Turn up a "starting Flange" (by using the slot cut in the table top for this purpose). Start the Flanger and feed the "starting flange" into the rolls from the right side. (The metal moves from right to left through the rolls as you face the machine.)

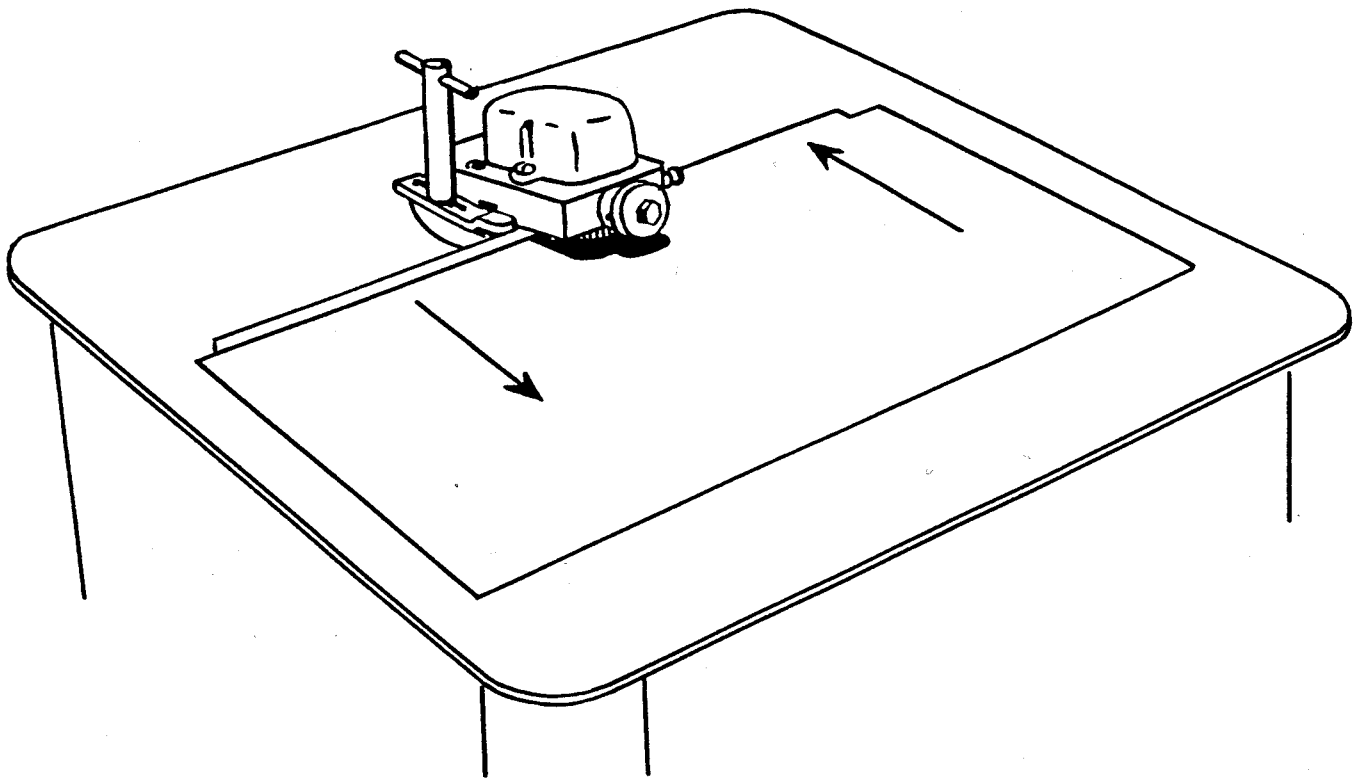

Press or push the metal being worked in accordance with the arrows in the accompanying sketch. When the piece is first started, it is easiest to push the right hand side of the metal being worked toward the machine or away from you; when the metal is about half way through, it is easiest to pull that part already flanged toward you. It will take one or two "practice" flanges before you will be able to turn a perfect flange; hence it is advisable to practice on waste stock before trying to flange an actual fitting.

If the flange comes from the rollers in a wrinkled or "buckled" condition, you are applying too much pressure; if the flange does not come up to the full height or "runs off" the piece being worked, you are applying too little pressure.

A buckled flange can be corrected by starting the same flange through the rollers a second time **AND BY APPLYING NO PRESSURE WHATEVER**. (Simply start the piece **AND LET GO**).

A low flange can be brought up to height by running it through the rollers again and applying slightly more pressures in so doing.

18 GA. POWER FLANGER - MASTER PARTS LIST

<u>Part No.</u>	<u>Description</u>	<u>Quantity</u>
27-001	Gear Housing	1
27-002	Gasket	1
27-003	Housing Cover - Casting	1
28-001	Forming Head	1
27-005	Dial	1
27-006	Vertical Shaft	1
27-007	Horizontal Shaft	1
27-008	Worm Gear	1
27-009	Worm Gear	1
27-010	15 Tooth Gear	2
10-011	Bearing B-108	2
11-010	Race IR-1316	1
27-024	Thrust Bearing #605-Nice	1
14-021	Bearing B-1412	2
27-011	Bronze Bushing P-64-12	2
27-012	Oil Seal CR-6229	1
11-012	Guide Roll Holder Assembly	1
11-014	Roll Guide Handle Assembly	1
11-016	Guide Roll	1
27-025	Gear Cover Assembly	1
27-023	Cabinet Assembly	1
10-031	Label-Manufacturer	1
10-032	Motor	1
10-038	Starter GE-5981-8	1
10-040	Label - Osha	1
10-042	Warning Label	1
27-019	Pulley AZ50	1
27-020	Pulley AZ30	1
27-021	"V" Belt 4L560	1
27-022	Freezer Plug Dorman-P14C	1
14-048	Motor Clamp Assembly	4
28-037	Knurled Roll	1
28-038	Plain Roll	1
27-039	Lifter Button	1

18 GA. POWER FLANGER

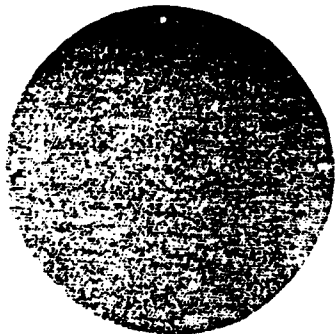

27-002



27-003

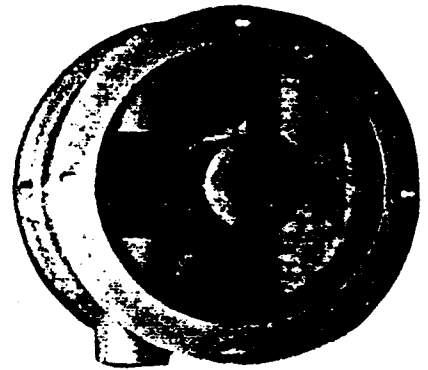

27-001



28-001

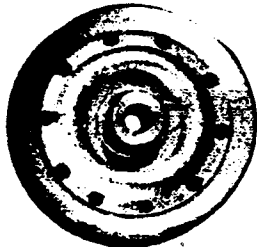

27-019

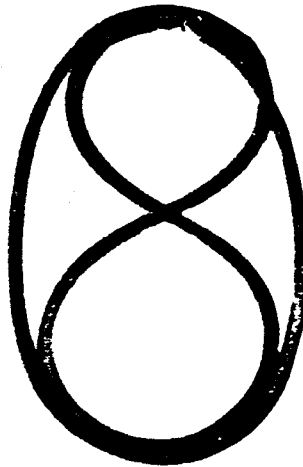

27-021



27-006

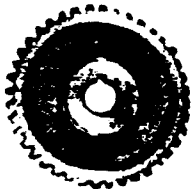

27-008



27-020



27-010

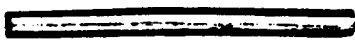

27-007



27-009



14-021



27-005



28-037



11-012



28-038

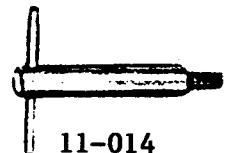

11-014

27-012



11-010



27-024



11-016



27-011



27-039